

Water Meter

for Irrigation and Waste Water

Turbo-IR

Features and Benefits

- Magnetic drive
- Dry, vacuum sealed register
- Option for “reed switch” sensor
- Register can rotate 360°
- Paddle wheel design prevents jamming and damage due to solid debris
- Measuring element suits range of water meter sizes
- Easy maintenance
- Can be installed in any orientation
- Low head loss.



The TURBO-IR uses a multi-blade plastic paddle mounted at the top of the water passage, where disturbance from solids suspended in the water is minimal, permitting accuracy of metering in water containing up to 30% solid debris.

Ideal for irrigation and waste water applications.



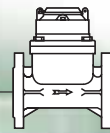

Technical Specifications

Dimensions and Weights

Size	in	2"	2½"	3"	4"	5"	6"	8"	10"	12"
	DN	50	65	80	100	125	150	200	250	300
L - Length (mm)		200	200	225	250	250	300	350	450	500
H - Height (mm)		252	262	279.5	289.5	303	332.5	386	441.5	493.5
Weight (kg)		10.5	11.8	15.5	17.5	19.5	30.5	42.5	60.0	82.5

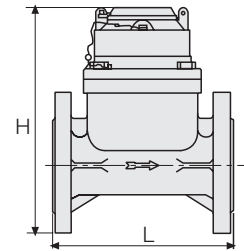

Accuracy Table

Size	in	2"	2½"	3"	4"	5"	6"	8"	10"	12"	
	DN	50	65	80	100	125	150	200	250	300	
Qmax - max. Flow	(m³/h)	70	100	150	250	350	500	900	1200	1600	
Qn - Nominal Flow	(m³/h)	35	50	75	125	175	250	450	600	800	
Qt - Transition Flow	(m³/h)	10.5	15	22.5	37.5	52.5	75	135	180	240	
Qmin - Min. Flow	(m³/h)	2.8	4	6	10	14	20	35	48	64	
Maximum Reading	(m³)	9999999.99						99999999.9			
Minimum Reading	(m³)	0.01						0.1			

Accuracy Curve

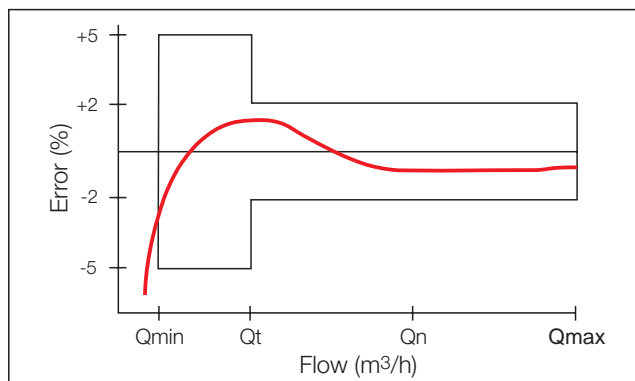

Flow Curve

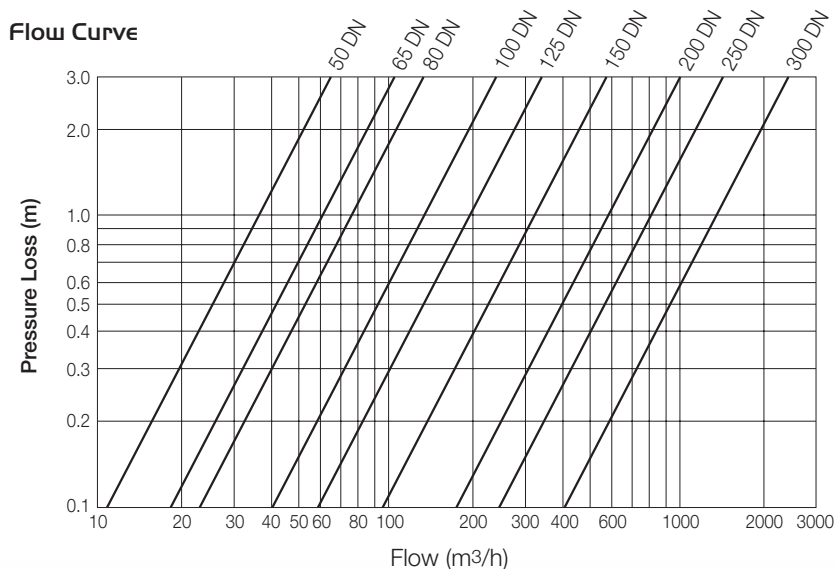

Operating Data

- **Pressure Rating:** 16 bar 232 psi
- **Temperature:** Water up to 40°C,; 105° F

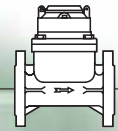

Installation

- The water meter can be installed in any orientation without interfering with metrological performance.
- Be sure to install so that water flow follows direction of arrow on water meter.

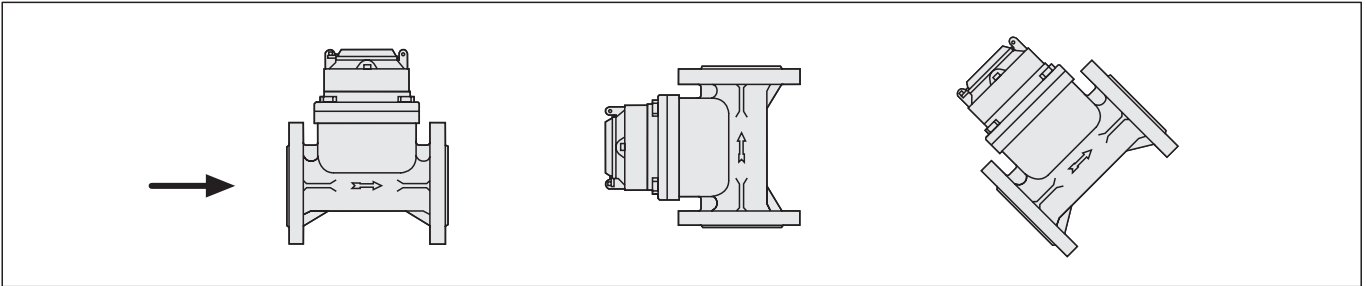

- To avoid turbulence that may interfere with accurate measurement, it is recommended to have 10 diameters of straight pipe upstream and 5 diameters downstream of water meter.
- Prior to installation, flush the line to remove debris.
- The TURBO-IR must be filled with water to operate.

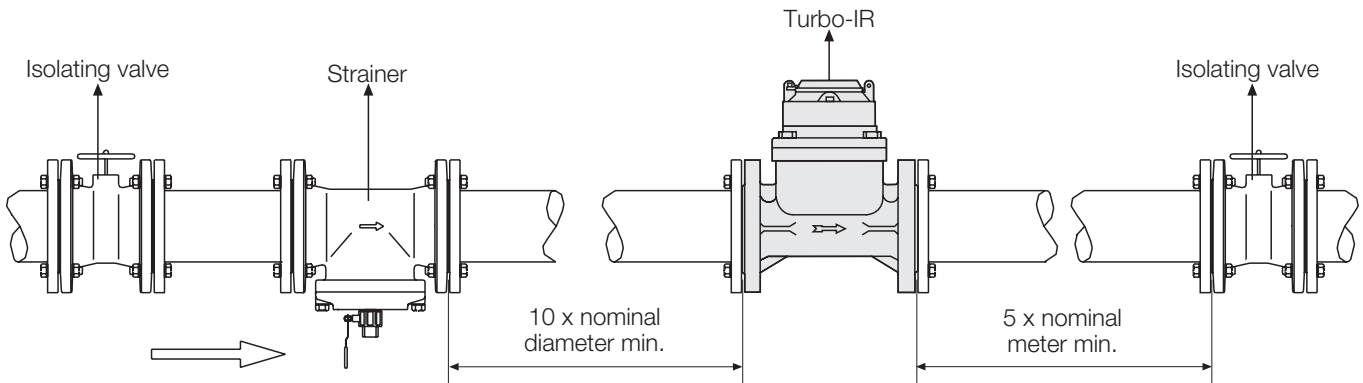

Reed Switch Assembly

- The Reed Switch pulser consists of plastic housing with a Reed Switch
- Cable: 2 core, 1.5m length
- Reed Switch: single
- Electrical Data:
Switching Volt.: 24 AV/DC max.
Switching Current: 0.01A max.

DN	Reed Switch Pulse		
	1 Pulse Per		
	100 liter	1 m ³	10 m ³
2"-6" 50-150	X	X	
8"-12" 200-300		X	X
Order Codes	S3	S2	S1

For pulse preparation add Y/to code

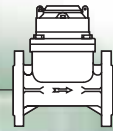

Ordering Guide

Example: TURBO-IR – 65 – BD – M3 – PG – Y/S2

Turbo-IR	50	16	M	PG	Y/S3
Type					
Turbo-IR					
Size					
Code					
2" - 50 mm	50				
2 1/2" - 65 mm	65				
3" - 80 mm	80				
4" - 100 mm	100				
5" - 125 mm	125				
6" - 150 mm	150				
8" - 200 mm	200				
10" - 250 mm	250				
12" - 300 mm	300				
Flange Drilling					
Code					
ISO-16	16				
ANSI-125	A1				
BSTD	BD				
ABNT	B6				
JIS16	J1				
ASTE	SE				
ASTD	SD				
Measure Units					
Code					
Cubic Meter	M3				
Coating					
Code					
Polyester Green	PG				

Output Pulse Options (add Y/ for output preparations)	Units	Code	Available
1 Pulse for each	100 Liter	S3	2"-6" 50-150 mm
	1m ³	S2	2"-12" 50-300 mm
	10m ³	S1	8"-12" 200-300 mm

